

# BASO 1.5 DIRECT

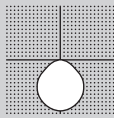

## PERFORMANCE

- Up to 98lm/W efficiency
- 400 / 550lm/ft
- CRI > 80 & CRI > 90
- Damp rated



## MOUNTING

Ceiling

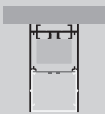

Pendant

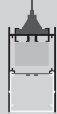

## PATTERNS



\*X Shapes



Angles



\*Wall to Ceiling



Rectangles



\*T Shapes

For customization, please contact customer service

## FIELD-CUTTABLE FLEX

Down to 1/16"



[link to video](#)

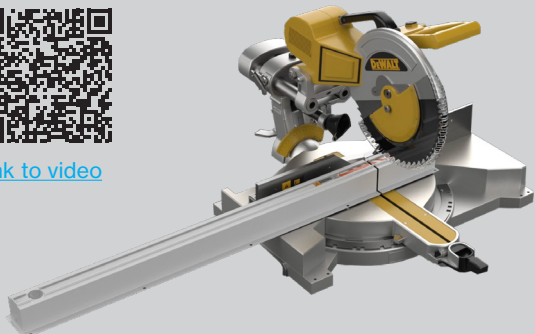

## Catalog Number Example

BASO 1.5-SUR-WH-OP-27K-C80-UNV-010V-SEN-0400LF-NLC-ST-24IN

### A RANGE

BASO 1.5      B A S O 1 . 5

### B MOUNTING

CS	Surface	SUR
	Surface in-line ACT T-BAR	SAT
	Surface in-line ACT SLOT	SAS
	Surface ACT center tile	SAC
CS	Pendant	PDT
	Pendant in-line ACT T-BAR	PAT
	Pendant in-line ACT SLOT	PAS
	Pendant ACT center tile	PAC

pendant suspension set includes cable suspension and one white power feeder with a white junction box cover

Wall mounted      W A L

for black power feeds or junction box covers, please contact customer service

### C COLOR

CS	White	WH
CS	Black	BL
	Gray	GR
	Custom color RAL	XX

### D LENS

HP opal cover      O P

### E CCT

	2700K	27K
CS	3000K	30K
CS	3500K	35K
	4000K	40K

### F CRI

	CRI > 80	C80
	CRI > 90	C90

### G VOLTAGE

120V / 277V      U N V

### H DIMMING

CS	0-10V 1%	010V
	Lutron EcoSystem	LES1
	Quantum, Vive, GRAFIK Eye, HomeWorks	
	Power over ethernet	POEC
	consult customer service for compatibility	
	Custom dimming	XXXX
	consult customer service for compatibility	

### I SENSOR (optional)

Integrated Sensor      S E N  
consult customer service for sensor request

### J OUTPUT LM/FT

CS	400lm/ft 100% ±	0400LF
CS	600lm/ft 100% ±	0600LF
CS	800lm/ft 100% ±	0800LF
	Custom lm/ft	XXXXLF
	custom lumen up to 1000 lm/ft	

### K CIRCUIT / EM

CS	Single circuit	*
	EMC night light circuit	NLC
	EMB available in 4ft and 8ft	EM#
	* leave blank	

### L SHAPE / PATTERN

CS	Linear / straight	ST
	Linear / straight + flex inset	SF
	includes 4ft. field-cutttable section	
	L-shape	LS
	□-shape (rectangular shape)	RS
	U-shape	US
	Custom shape	XX

### M DIMENSIONS IN INCH

	Linear 2'	24IN
CS	Linear 4'	48IN
CS	Linear 6'	72IN
CS	Linear 8'	96IN
	Linear custom	###IN
	Linear flex inset	###IN
	field-cutttable section	
	L-Shape	##X###IN
	U-Shape	##X##X###IN
	□-Shape	##X##IN



for lengths including flex insets, round up to the nearest total foot length

### N CERTIFICATION (optional)

Red List Approved      R L A

**BASO**  
basolighting.com  
xalusa.com

### Technical data

	SIZE TYPE	LED COLOR TEMPERATURE	INPUT WATTS	DELIVERED LM TOTAL	LIGHT DISTRIBUTION	DELIVERED LM DIRECT	DELIVERED LM INDIRECT	OPTICAL EFFICIENCY	LUMINAIRE EFFICACY	
<b>BASO DIRECT</b>										
	e LED	2' linear	40K	8.2W	800lm	100% down	400lm/ft	-	67%	98lm/W
		4' linear		16.4W	1610lm					
		8' linear		32.8W	3220lm					
		2' + 2' corner		16.4W	1610lm					
	e <sup>2</sup> LED	2' linear	40K	11.75W	1100lm	100% down	550lm/ft	-	67%	94lm/W
		4' linear		23.5W	2200lm					
		8' linear		47W	4410lm					
		2' + 2' corner		23.5W	2200lm					

for 30 K or 35 K multiply lm value by 0.96

### Patterns top view

#### LINEAR

A	FIXTURES	CODE
48"	1 × 4' linear	ST - 0 4 F T
96"	1 × 8' linear	ST - 0 8 F T
144"	3 × 4' linear	ST - 1 2 F T



#### L-SHAPE

A / B	FIXTURES	CODE
48" / 48"	2 × 2' linear + 1 × 2' × 2' corner	LS - 0 4 X 0 4 F T
48" / 96"	1 × 2' linear + 1 × 6' linear + 1 × 2' × 2' corner	LS - 0 4 X 0 8 F T
96" / 96"	2 × 6' linear + 1 × 2' × 2' corner	LS - 0 8 X 0 8 F T

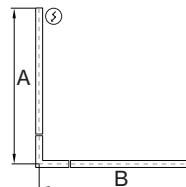

#### □-SHAPE (rectangular shape)

A / B	FIXTURES	CODE
48" / 48"	4 × 2' × 2' corner	RS - 0 4 X 0 4 F T
48" / 96"	2 × 4' linear + 4 × 2' × 2' corner	RS - 0 4 X 0 8 F T
96" / 96"	4 × 4' linear + 4 × 2' × 2' corner	RS - 0 8 X 0 8 F T

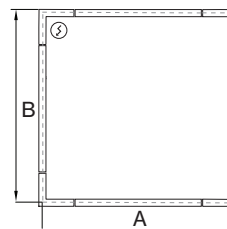

#### U-SHAPE

A / B / C	FIXTURES	CODE
48" / 48" / 48"	2 × 2' linear + 2 × 2' × 2' corner	US - 0 4 X 0 4 X 0 4 F T
48" / 96" / 48"	1 × 4' linear + 2 × 2' linear + 2 × 2' × 2' corner	US - 0 4 X 0 8 X 0 4 F T
48" / 144" / 48"	1 × 8' linear + 2 × 2' linear + 2 × 2' × 2' corner	US - 0 4 X 1 2 X 0 4 F T

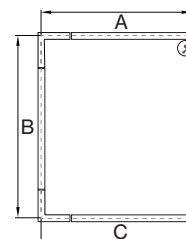

DIMENSIONS

**BASO 1.5**

SURFACE  
direct

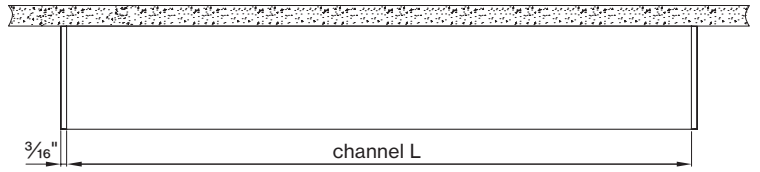
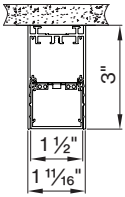

PENDANT  
direct

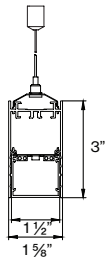

direct / indirect

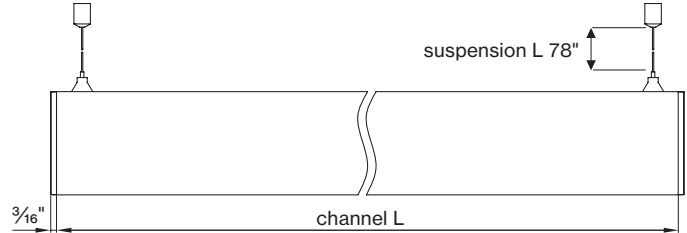
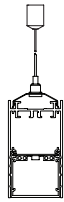

**BASO 1.5 SPECIALITY MOUNTING**

SURFACE  
in-line ACT TBAR

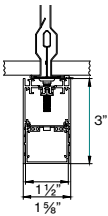

SURFACE  
in-line ACT SLOT

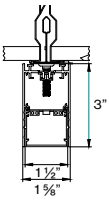

SURFACE  
ACT center tile

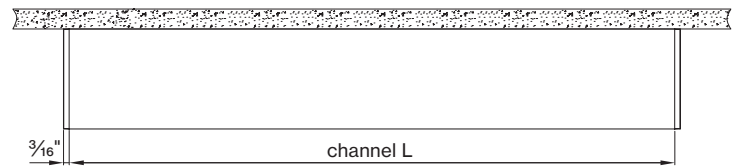
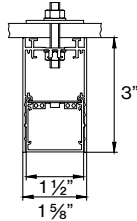

PENDANT  
ACT TBAR

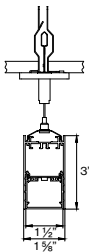

PENDANT  
in-line ACT SLOT

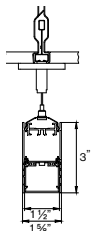

PENDANT  
ACT center tile

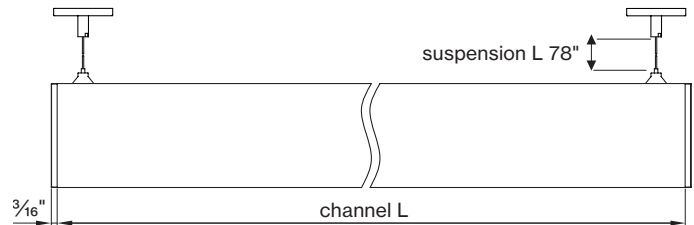
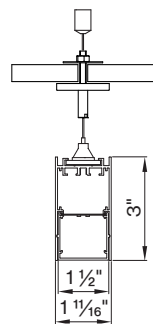

**BASO mounting instructions**

Get access to the BASO 1.5 mounting instructions faster by scanning the QR code.

[www.xalusa.com/resources/mounting-instructions/baso](http://www.xalusa.com/resources/mounting-instructions/baso)

